

CARACTERÍSTICAS / FEATURES

Material hormigón petra2 + madera
Acabado decapado e hidrofugado + barnizado
Dimensiones l. 226, a. 68, h. 60 cm
Color ver carta de colores
Fijación simplemente apoyado o mediante varillas metálicas
Peso 180 Kg
Palet 120 x 100 x 200cm [2 bancos]
Peso bruto 510 Kg

Material precast concrete petra2 + wood
Finish scaled and waterproofed + varnished
Dimensions l. 226, w. 68, h. 60 cm
Colour see colour catalogue
Fixing resting on the ground or anchored with metal rod
Weight 180Kg
Package 120 x 100 x 200cm [2 benches]
Weight package 510 Kg

diseñador / design: I+D mago:urban



Free phone: 0808 101 1590
 email: sales@publicspaces.eu
 Web: www.publicspaces.eu

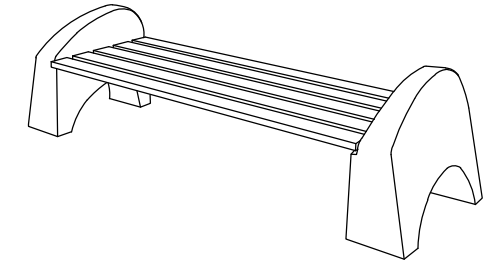

GEOMETRIA / GEOMETRY

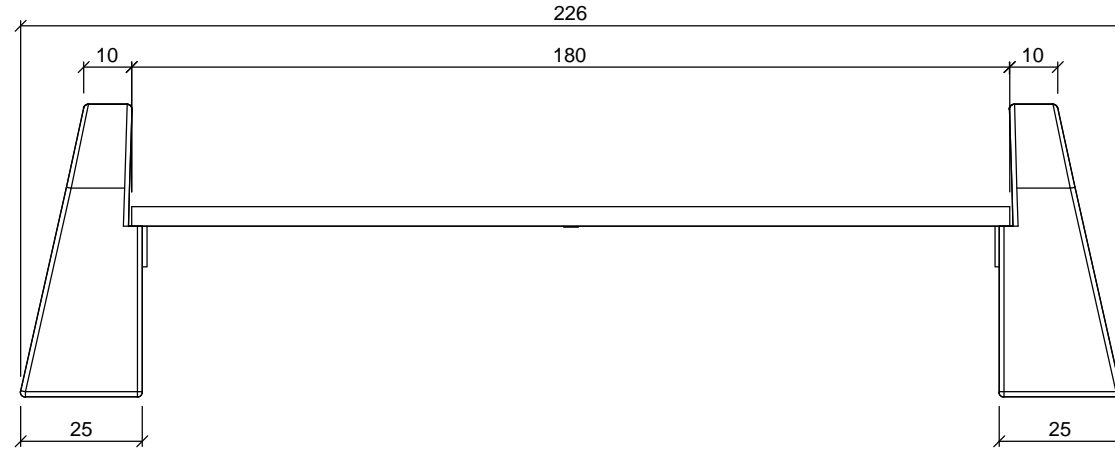

ALZADO / FRONT VIEW

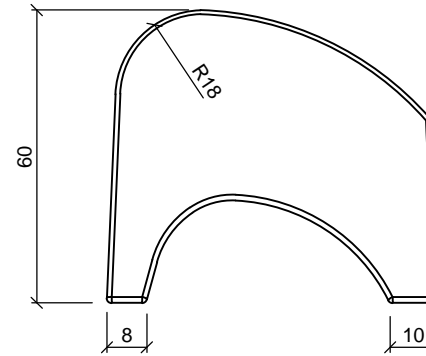

PERFIL / RIGHT SIDE

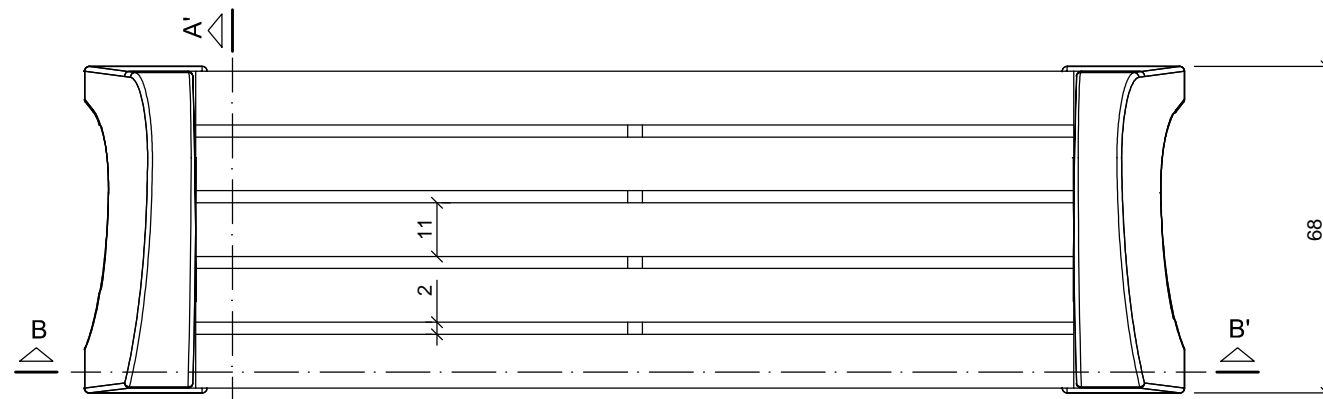

PLANTA / TOP VIEW



MANIPULACIÓN E INSTALACIÓN / HANDLING AND INSTALLATION

- 1 Instalar a una distancia el uno del otro de $\pm 180,5$ cm y ajustar mediante regle
 Install each other at a distance of $\pm 180,5$ cm and adjust with a leveler

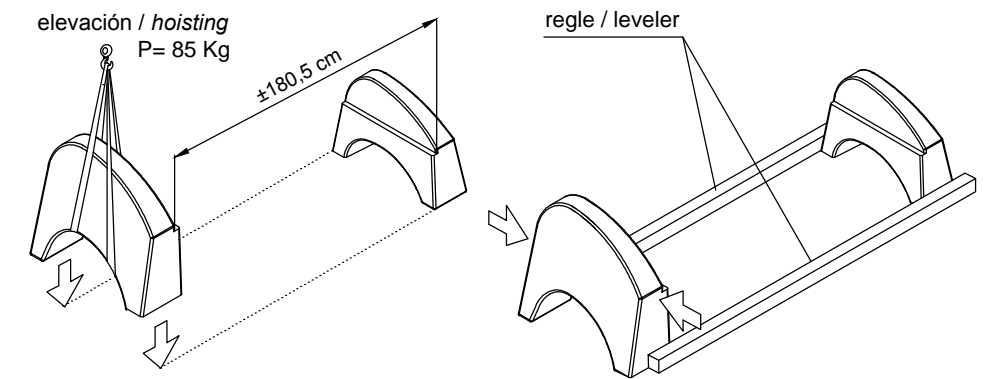

- 2 Instalar accesorio fijando mediante tornillos y arandela
 Install accessories fixing them with screwings and nut

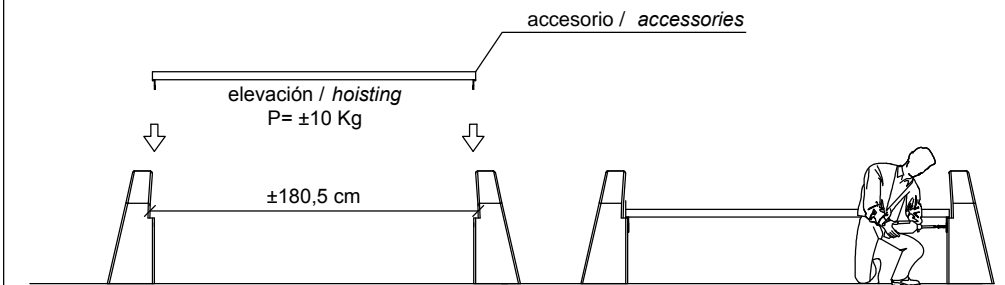

ESPECIFICACIONES / SPECIFICATIONS

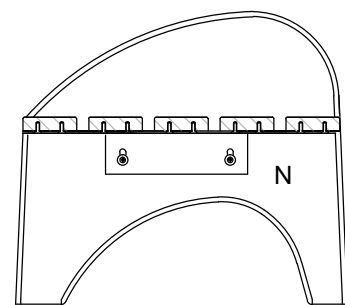

SECCIÓN A-A' / SECTION A-A'

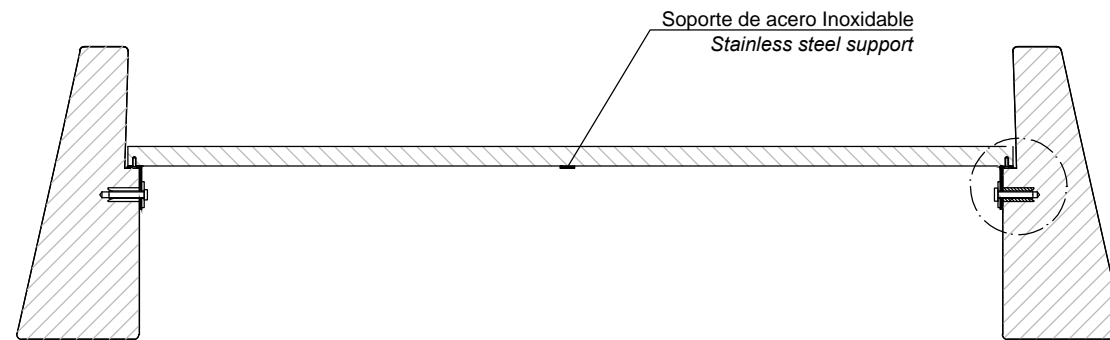

SECCIÓN A-A' / SECTION A-A'

Madera Bolondo 180 x11 x3.5cm
 Wooden Bolondo 180 x11 x3.5cm

Arandela 10,5 - DIN9021
 Nut 10,5 - DIN9021

Soporte de acero Inoxidable
 Stainless steel support

Tornillo 5x35 T25 - DIN9130
 Screw 5x35x T25 - DIN9130

Taco metálico
 Metallic expansion shell

Tornillo de taco metálico de expansión 8x165
 Screw with metallic expansion shell 8x165

Base de hormigón
 Concrete base

DETALLE N / DETAIL N