

GEOMETRY

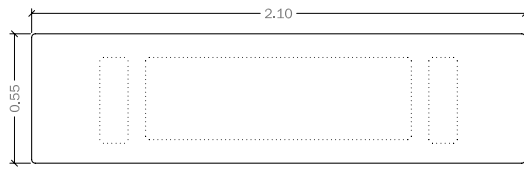

Plant

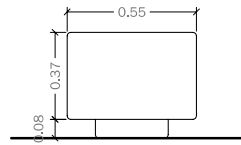

Profile

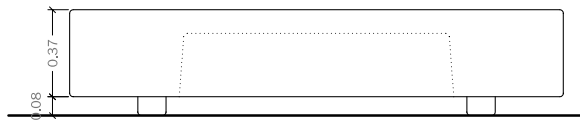

Elevation

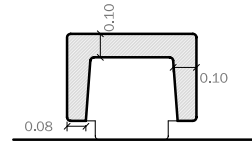

Cross section

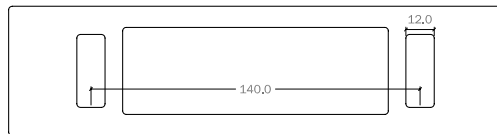

Bottom plant

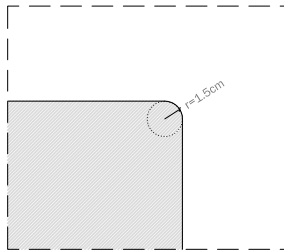

Edge detail

scale (in cm.) 0 50

POSITIONING

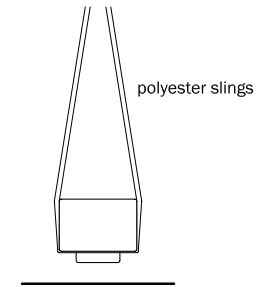

polyester slings

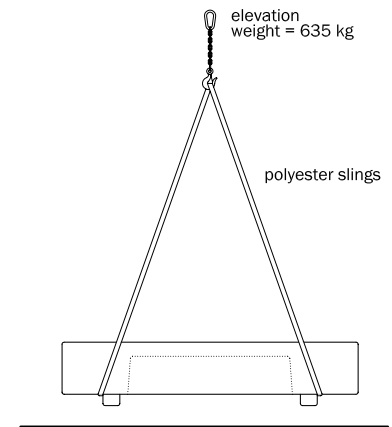

elevation weight = 635 kg

polyester slings

Fastening system
Base supported

GANDHI

Prism with rounded edges and corners. This geometrical detail gives it a gentle and non-aggressive appearance.

It is supported by two solid legs which are part of the main the piece.

It is an ideal element to be situated individually or combined with the Cub B model.

patented model ©



MATERIAL : Architectural Concrete
COLOUR : White, Grey, Beige
TEXTURE : Stripped, Plain
FINISH : Water Repellent
WEIGHT : 635 Kg
INSTALLATION : Base Supported

DESIGN : Internal team

